

**Chiavi a bussola a mano esagonali 1/4"**  
acciaio al cromo vanadio - cromate  
*Square drive sockets 6 points*

1/4"



Cod.				
20701	4	25	1	10
20702	4,5	25	1	10
20703	5	25	1	10
20704	5,5	25	1	10
20705	6	25	1	11
20706	7	25	1	11
20707	8	25	1	11
20708	9	25	1	13
20709	10	25	1	14
20710	11	25	1	17
20711	12	25	1	18
20712	13	25	1	22

**Asta con quadro scorrevole 1/4"**  
acciaio al cromo vanadio - cromata  
*1/4" - Sliding T bar*

1/4"



Cod.			
20761	115	1	44

**Prolunghe attacco quadro maschio e femmina 1/4"**  
acciaio al cromo vanadio - cromate  
*1/4" - Extension bars*

1/4"



Cod.			
20763	50	1	22
20764	100	1	40

**Prolunghe angolari attacco quadro maschio e femmina 1/4"**  
acciaio al cromo vanadio - cromate  
*1/4" - Wobble extension bars*

1/4"



Cod.			
20773	50	1	22
20774	100	1	40
20775	250	1	110



ANGOLARE

**Snodo cardanico attacco 1/4"**  
acciaio al cromo vanadio - cromato  
*1/4" - Universal joint*

1/4"



Cod.			
20765	41	1	40

**Raccordo attacco quadro femmina 1/4"**  
acciaio al cromo vanadio - cromato  
*1/4" adapter*

1/4"



Cod.			
20068	1/4"(F)x3/8"(M)	35	1 45

**Cricchetto reversibile attacco maschio 1/4"**  
72 denti a sgancio rapido - acciaio al cromo vanadio - cromato  
*1/4" - Reversible ratchet handle - quick release*

1/4"



Cod.			
20754	155	1	138

**Cricchetto reversibile attacco maschio 1/4"**  
72 denti ergonomico a sgancio rapido - acciaio al cromo vanadio - cromato  
*1/4" reversible ratchet handle - quick release*

1/4"



Cod.			
20750	150	1	135

**Cricchetto estensibile reversibile attacco maschio 1/4"**  
 72 denti a sgancio rapido - lung. chiuso 150 mm esteso 200 mm -  
 acciaio al cromo vanadio - cromato  
*1/4" extensible ratchet handle - quick release*

1/4"

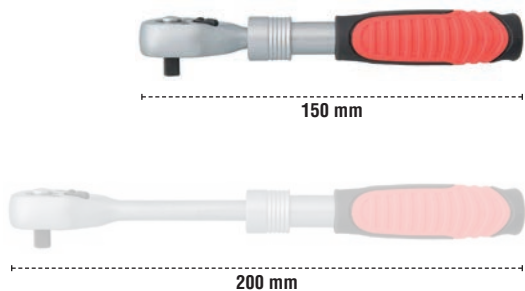

Cod.			
<b>20753</b>	150/200	1	184

**Chiave a T snodata 1/4"**  
 quadro maschio con snodo e asta frizionata  
 acciaio al cromo vanadio - cromata  
*1/4" - T handle wrench with universal joint*

1/4"

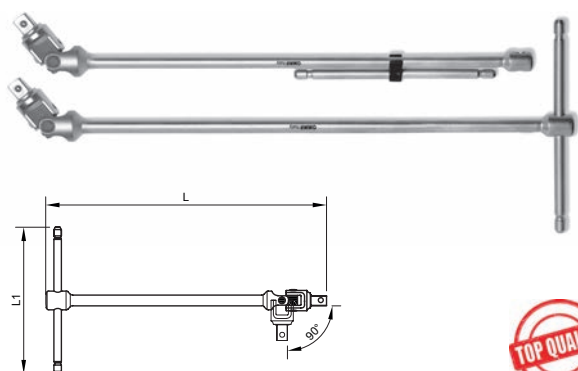

Cod.		L	ØxL1		
<b>20776RC</b>	1/4"	395	7x165	1	221

**Chiave a T snodata con 7 bussole esagonali 1/4"**  
 acciaio al cromo vanadio - cromata  
*1/4" - T handle wrench with universal joint  
 and square drive sockets 6 points*

1/4"

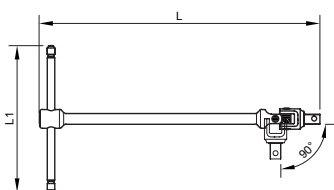

Cod.	Pz./Pcs.		
<b>20776RC/8</b>	8	1	335

**Composizione:**  
 1 chiave a T con attacco quadro snodato 1/4"  
 7 bussole mm. 5-5,5-6-7-8-9-10

**Assortimento 46 chiavi a bussola, e accessori 1/4"**  
 acciaio al cromo vanadio - cromate - cassetta plastica  
*1/4" - Square drive socket 6 points and accessory set - 46 pcs.*

1/4"



Cod.	Pz./Pcs.		
<b>20720</b>	46	1	1200

**Composizione:**  
 13 bussole esagonali mm 4-4,5-5-5,5-6-7-8-9-10-11-12-13-14  
 1 cricchetto reversibile 72 denti  
 1 prolunga mm 50  
 1 prolunga mm 100  
 1 asta con quadro scorrevole  
 1 snodo cardanico  
 1 prolunga flessibile  
 4 chiavi maschio esagonale mm 1,27-1,5-2-2,5  
 1 adattatore 1/4"(M) x 1/4"(F)  
 6 bussole esagoni maschio mm 3-4-5-6-7-8  
 3 bussole inserto a lama maschio mm 4-5-5-7  
 3 bussole inserto PH maschio PH1-PH2-PH3  
 3 bussole inserto PZ maschio PZ1-PZ2-PZ3  
 6 bussole inserto TX maschio T10-T15-T20-T25-T30-T40  
 1 impugnatura a cacciavite con attacco maschio

**Chiavi a bussola a mano poligonali 3/8"**  
 acciaio al cromo vanadio - cromate  
*3/8" - Square drive sockets 12 points*

3/8"



Cod.				
<b>20801</b>	6	27	1	25
<b>20802</b>	7	27	1	25
<b>20803</b>	8	27	1	25
<b>20804</b>	9	27	1	25
<b>20805</b>	10	27	1	25
<b>20806</b>	11	27	1	25
<b>20807</b>	12	30	1	25
<b>20808</b>	13	30	1	25
<b>20809</b>	14	30	1	30
<b>20810</b>	15	30	1	40
<b>20811</b>	16	30	1	40
<b>20812</b>	17	30	1	55
<b>20813</b>	18	30	1	55
<b>20814</b>	19	30	1	60
<b>20815</b>	20	30	1	70
<b>20816</b>	21	30	1	75
<b>20817</b>	22	30	1	75

**Chiavi a bussola a mano esagonali 3/8"**  
acciaio al cromo vanadio - cromate  
**3/8" - Square drive sockets 6 points**

3/8"



Cod.				
20901	6	27	1	25
20902	7	27	1	25
20903	8	27	1	25
20904	9	27	1	25
20905	10	27	1	25
20906	11	27	1	25
20907	12	30	1	25
20908	13	30	1	25
20909	14	30	1	30
20910	15	30	1	40
20911	16	30	1	40
20912	17	30	1	55
20913	18	30	1	55
20914	19	30	1	60
20915	20	30	1	70
20916	21	30	1	80
20917	22	30	1	80

**Asta con quadro scorrevole 3/8"**  
acciaio al cromo vanadio - cromata  
**3/8" - Sliding T bar**

3/8"



Cod.			
20061	200	1	160

**Quadro maschio snodato 3/8"**  
acciaio al cromo vanadio - cromato  
**3/8" - Flexible handle**

3/8"



Cod.			
20062	200	1	315

**Prolunghe attacco quadro maschio e femmina 3/8"**  
acciaio al cromo vanadio - cromate  
**3/8" - Extension bars**

3/8"



Cod.			
20063	125	1	120
20064	250	1	235

**Prolunghe attacco quadro maschio e femmina 3/8"**  
maschio angolare - acciaio al cromo vanadio - cromate  
**3/8" - Wobble extension bars**

3/8"



ANGOLARE

Cod.			
20863	75	1	67
20864	150	1	140
20865	250	1	235

**Snodo cardanico 3/8"**  
acciaio al cromo vanadio - cromato  
**3/8" - Universal joint**

3/8"



Cod.			
20065	55	1	60

**Raccordi attacco quadro 3/8"**  
acciaio al cromo vanadio - cromati  
**3/8" - Adapters**

3/8"



Cod.			
20066	3/8" (F) x 1/4" (M)	25	1 20
20067	3/8" (F) x 1/2" (M)	35	1 45

**Cricchetto reversibile attacco maschio 3/8"**  
72 denti a sgancio rapido  
acciaio al cromo vanadio - cromato  
**3/8" - Reversible ratchet handle - quick release**

3/8"



Cod.			
20053	112	1	323

**Cricchetto reversibile attacco maschio 3/8"**  
72 denti ergonomico a sgancio rapido  
acciaio al cromo vanadio - cromato  
**3/8" reversible ratchet handle - quick release**

3/8"



Cod.			
20050	200	1	290

**Cricchetto reversibile da 3/8" a 36 denti**  
acciaio al cromo vanadio - cromato  
*3/8" - Reversible ratchet handle*

3/8"



Cod.			
20051	200	1	340

LINEA BASIC

**3/8" - Chiave a T snodata quadro maschio con snodo e asta frizionata**  
acciaio al cromo vanadio - cromata  
*3/8" - T handle wrench with universal joint*

3/8"

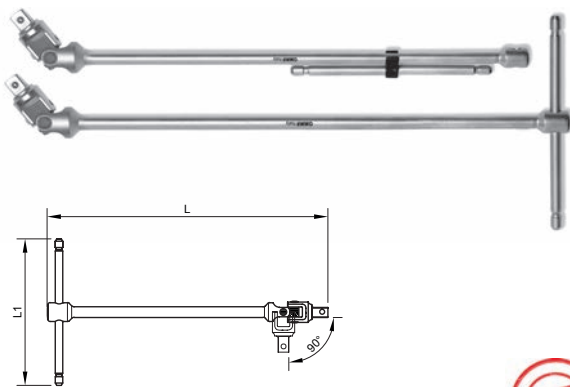

Cod.		L	ØxL1		
20076RC	3/8"	445	9x180	1	450



**Manovella 3/8"**  
acciaio al cromo vanadio - cromata  
*3/8" - Speeder handle*

3/8"



Cod.			
20071	390	1	480

**Snodo IMPACT universale 3/8"**  
acciaio al cromo vanadio - fosfatato  
*3/8" universal joint impact*

3/8"



Cod.			
1864	52	1	85

**Chiavi a bussola a mano poligonali in pollici 1/2"**  
acciaio al cromo vanadio - cromate  
*1/2" - Square drive sockets 12 points*

1/2"

POLLICI



Cod.				
21002P	7/16"	38	1	50
21003P	1/2"	38	1	52
21006P	5/8"	38	1	50
21010P	3/4"	38	1	66
21013P	7/8"	38	1	88
21016P	1"	40	1	123
21018P	1 1/8"	45	1	167
21019P	1 1/4"	45	1	209

**Chiavi a bussola a mano poligonali 1/2"**  
acciaio al cromo vanadio - cromate  
*1/2" - Square drive sockets 12 points*

1/2"



Cod.				
20999	8	36	1	38
21000	9	36	1	40
21001	10	36	1	45
21002	11	36	1	50
21003	12	36	1	50
21004	13	36	1	50
21005	14	38	1	52
21006	15	36	1	50
21007	16	36	1	55
21008	17	36	1	55
21009	18	38	1	50
21010	19	38	1	70
21011	20	38	1	70
21012	21	38	1	90
21013	22	38	1	90
21014	23	38	1	90
21015	24	38	1	90
21016	25	38	1	95
21017	26	38	1	95
21018	27	38	1	88
21019	30	40	1	110
21020	32	42	1	125

**Chiavi a bussola a mano esagonali 1/2"**  
acciaio al cromo vanadio - cromate  
*1/2" - Square drive sockets 6 points*

1/2"

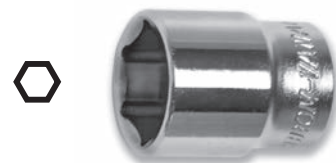

Cod.				
21024	8	36	1	40
21025	9	36	1	40
21026	10	36	1	45
21027	11	36	1	50
21028	12	36	1	50
21029	13	36	1	50



Cod.	mm			
21030	14	36	1	55
21031	15	36	1	55
21032	16	36	1	70
21033	17	38	1	70
21034	18	38	1	90
21035	19	38	1	90
21036	20	38	1	90
21037	21	38	1	95
21038	22	38	1	95
21039	23	40	1	110
21040	24	42	1	125
21041	25	42	1	150
21042	26	42	1	155
21043	27	42	1	170
21044	28	42	1	170
21045	30	45	1	215
21046	32	45	1	240

1/2"

**Chiavi a bussola a mano poligonali lunghe da 1/2"**  
acciaio al cromo vanadio - cromate  
*1/2" - Square drive deep wall sockets 12 points*

1/2"



Cod.				
21004L	13	76	1	120
21008L	17	76	1	140
21010L	19	76	1	180
21013L	22	76	1	240
21015L	24	76	1	250
21018L	27	76	1	320
21019L	30	76	1	325
21020L	32	76	1	390

**Asta con quadro scorrevole 1/2"**  
acciaio al cromo vanadio - cromata  
*1/2" - Sliding T bar*

1/2"



Cod.			
21061	250	1	370

**Quadro maschio snodato 1/2"**  
acciaio al cromo vanadio - cromato  
*1/2" - Flexible handle*

1/2"



Cod.			
21062	375	1	720

**Prolunghe attacco quadro maschio e femmina 1/2"**  
acciaio al cromo vanadio - cromate  
*1/2" - Extension bars*

1/2"



Cod.			
21063	125	1	200
21064	250	1	355

**Prolunghe attacco quadro maschio e femmina 1/2"**  
maschio angolare - acciaio al cromo vanadio - cromate  
*1/2" - Wobble extension bars*

1/2"



Cod.			
21093	50	1	100
21094	125	1	198
21095	250	1	430

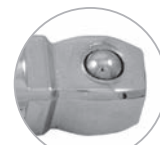

ANGOLARE

**Serie 3 prolunghe a sgancio rapido 1/2"**  
acciaio al cromo vanadio - cromate  
*1/2" - Extension bar with quick release set - 3 pcs.*

1/2"

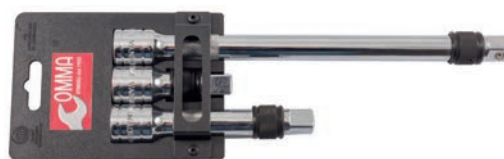

Cod.			
21060/3	75-150-300	1	2885

**Serie 9 prolunghe angolari 1/4"-3/8"-1/2"**  
acciaio al cromo vanadio - cromate  
*9 pcs. wobble extension set*

1/4"

3/8"

1/2"



ANGOLARE



Cod.			
21060/9	3 pz. 1/4" (50 mm) (100 mm) (250 mm)	1	1435
	3 pz. 3/8" (75 mm) (150 mm) (250 mm)		
	3 pz. 1/2" (50 mm) (125 mm) (250 mm)		

**Manovella attacco quadro 1/2"**  
acciaio al cromo vanadio - cromata  
*1/2" - Speeder handle*

1/2"



Cod.			
21071	420	1	500

**Snodo cardanico attacco 1/2"**  
acciaio al cromo vanadio - cromato  
*1/2" - Universal joint*

1/2"



Cod.	Icona 1	Icona 2	Icona 3
21065	75	1	140

**Raccordi attacco quadro 1/2"**  
acciaio al cromo vanadio - cromati  
*1/2" - Adapters*

1/2"



Cod.	Icona 1	Icona 2	Icona 3
21067	1/2"(F) x 3/8"(M)	43	1 55
21066	1/2"(F) x 3/4"(M)	41	1 140

**Cricchetto reversibile attacco maschio 1/2"**  
72 denti a sgancio rapido - acciaio al cromo vanadio - cromato  
*1/2" - Reversible ratchet handle-quick release*

1/2"



Cod.	Icona 1	Icona 2	Icona 3
21054	256	1	513

**Cricchetto reversibile attacco maschio 1/2"**  
72 denti ergonomico a sgancio rapido -acciaio al cromo vanadio - cromato  
*1/2" reversible ratchet handle - quick release*

1/2"



Cod.	Icona 1	Icona 2	Icona 3
21050	245	1	580

**Cricchetto estensibile reversibile attacco maschio 1/2"**  
72 denti a sgancio rapido - lunghezza chiuso 300 mm esteso 400 mm  
acciaio al cromo vanadio - cromato  
*1/2" extensible ratchet handle - quick release*

1/2"



Cod.	Icona 1	Icona 2	Icona 3
21053	300/400	1	958

LINEA BASIC

**Cricchetto reversibile da 1/2" a 36 denti**  
acciaio al cromo vanadio - cromato  
*1/2" - Reversible ratchet handle*

1/2"



Cod.	Icona 1	Icona 2	Icona 3
21051	250	1	550

LINEA BASIC

**Cricchetto reversibile da 1/2" a 24 denti quadro femmina**  
acciaio al cromo - cromato  
*1/2" - Reversible ratchet handle-female square*

1/2"



Cod.	Icona 1	Icona 2	Icona 3
21055	275	1	527

**1/2" - Chiave a T snodata quadro maschio con snodo e asta frizionata**  
acciaio al cromo vanadio - cromata  
*1/2" - T handle wrench with universal joint*

1/2"

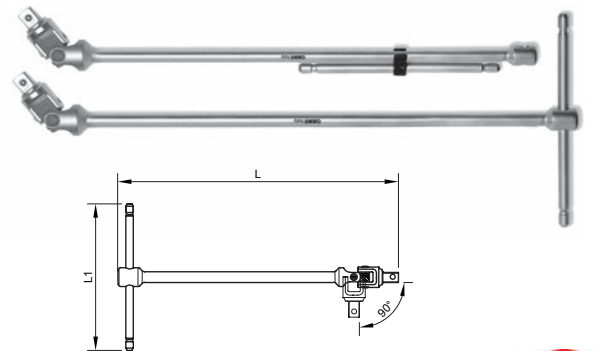

Cod.	Icona 1	L	ØxL1	Icona 2	Icona 3
21076RC	1/2"	505	11x230	1	905
21076LRC	1/2"	1100	11x230	1	1910



**Assortimento 27 chiavi a bussola esagonali e accessori 1/2"**  
acciaio al cromo vanadio - cromate - cassetta plastica  
*1/2" - Square drive socket 6 points and accessory set - 27 pcs.*

1/2"



Cod.	Pz./Pcs.		
21113	27	1	3800

Composizione:

20 bussole esagonali mm 8-9-10-11-12-13-14-15-16  
17-18-19-20-21-22-23-24-27-30-32  
1 cricchetto reversibile 72 denti  
1 prolunga mm 125  
1 prolunga mm 250  
1 snodo cardanico  
1 bussola per candele mm 16  
1 bussola per candele mm 21  
1 raccordo aumentatore 3/8" (F) x 1/2" (M)

**Assortimento 27 chiavi a bussola poligonali e accessori 1/2"**  
acciaio al cromo vanadio - cromate - cassetta plastica  
*1/2" - Square drive socket 12 points and accessory set - 27 pcs.*

POLIGONALE



1/2"

Cod.	Pz./Pcs.		
21114	27	1	3800

Composizione:

20 bussole mm 8-9-10-11-12-13-14-15-16  
17-18-19-20-21-22-23-24-27-30-32  
1 cricchetto reversibile 72 denti  
1 prolunga mm 125  
1 prolunga mm 250  
1 snodo cardanico  
1 bussola per candele mm 16  
1 bussola per candele mm 21  
1 raccordo aumentatore 3/8" (F) x 1/2" (M)

**Assortimento 108 chiavi a bussola e accessori**  
attacco da 1/2" e 1/4" in cassetta plastica  
*1/2" and 1/4" Square drive socket and accessory set - 108 pcs.*

1/2"

1/4"



Cod.	Pz./Pcs.		
21108	108	1	7000

Composizione:

17 bussole esagonali attacco 1/2"  
mm 10-11-12-13-14-15-16-17-18-19-20-21-22-24-27-30-32  
1 cricchetto reversibile 1/2"  
5 bussole esagonali attacco 1/2" femmina tipo lungo mm 14-15-17-19-22  
2 bussole per candele attacco 1/2" mm 16-21  
8 bussole attacco 1/2" TX femmina E10-E11-E12-E14-E16-E18-E20-E24  
2 prolunghe attacco 1/2" mm 125 - mm 250  
1 snodo cardanico 1/2"  
1 bussola scorrevole attacco 1/2" con quadro 1/2"  
1 bussola attacco 1/2" esagonale per inserti da 1/4"  
3 chiavi a brugola esagonali mm 1,5-2-2,5  
13 bussole attacco 1/4" esagonali femmina  
mm 4-4,5-5-5,5-6-7-8-9-10-11-12-13-14  
8 bussole esagonali attacco 1/4" femmina tipo lungo  
mm 6-7-8-9-10-11-12-13  
4 bussole attacco 1/4 con inserto esagonale mm 3-4-5-6  
3 bussole attacco 1/4" con inserto a lama mm 4-5,5-6,5  
2 bussole attacco 1/4" con inserto a croce Phillips PH1-PH2  
2 bussole attacco 1/4" con inserto a croce Pozidrive PZ1-PZ2  
7 bussole attacco 1/4" con inserto TX T8-T10-T15-T20-T25-T27-T30  
5 bussole attacco 1/4" TX femmina E4-E5-E6-E7-E8  
1 cricchetto reversibile 1/4"  
1 asta con quadro scorrevole 1/4"  
1 snodo cardanico 1/4"  
1 impugnatura a cacciavite 1/4"  
2 prolunghe attacco 1/4" mm 50 - mm 100  
4 inserti esagonali attacco 1/4" mm 8-10-12-14  
3 inserti a lama attacco 1/4" mm 8-10-12  
2 inserti a croce Phillips attacco 1/4" PH3-PH4  
2 inserti a croce Pozidrive attacco 1/4" PZ3-PZ4  
5 inserti TX attacco 1/4" T40-T45-T50-T55-T60

1/2"

1/4"



**Assortimento 19 chiavi a bussola "SPLINE" - MULTIMPRONTA**  
in cassetta plastica  
**1/2" - "SPLINE" Socket set - 19 pcs.**

1/2"



Cod.	Pz./Pcs.		
21191	19	1	1935

Composizione:

mm	inch			
8	5/16"		E10	
9	11/32"			
10	3/8"		E12	8
11	7/16"		E14	9
12	15/32"		E16	10
13	1/2"			
14	9/16"		E18	
15	19/32"			12
16	5/8"		E20	13
17				14
18			E22	
19	3/4"		E24	
20	25/32"			16
21	13/16"		E26	17
22	7/8"		E28	18
24	15/16"		E30	19
27	1. 1/16"		E34	22
30	1. 3/16"		E38	24
32	1. 1/4"		E40	26

**Chiavi a bussola IMPACT esagonali 1/2"**  
acciaio al cromo molibdeno - brunite  
**1/2" - Hexagonal square drive impact sockets**

1/2"



Cod.				
1810	10	38	1	80
1812	12	38	1	80
1813	13	38	1	80
1814	14	38	1	85
1815	15	38	1	85
1816	16	38	1	90
1817	17	38	1	100
1818	18	38	1	110
1819	19	38	1	130
1820	20	38	1	135
1821	21	38	1	140
1822	22	38	1	150
1824	24	38	1	180
1827	27	38	1	200
1830	30	38	1	240
1832	32	38	1	260

**Chiavi a bussola esagonali lunghe IMPACT 1/2"**  
acciaio al cromo molibdeno - brunite  
**1/2" - Hexagonal square drive deep real impact sockets**

1/2"



Cod.				
1810L	10	78	1	120
1812L	12	78	1	120
1813L	13	78	1	120
1814L	14	78	1	130
1815L	15	78	1	130
1816L	16	78	1	140
1817L	17	78	1	150
1818L	18	78	1	170
1819L	19	78	1	190
1820L	20	78	1	200
1821L	21	78	1	210
1822L	22	78	1	220
1824L	24	78	1	260
1827L	27	78	1	340
1830L	30	78	1	430
1832L	32	78	1	500

**Assortimento 10 chiavi a bussola esagonali IMPACT 1/2"**  
in cassetta di metallo - acciaio al cromo molibdeno - brunite  
**1/2" - Square drive impact socket 6 points set - 10 pcs.**

1/2"



Cod.	Pz./Pcs.		
1800/10	10	1	1205

Composizione:  
10-12-13-14-15-17-19-21-22-24

**Assortimento 10 chiavi a bussola esagonali lunghe IMPACT 1/2"**  
in cassetta di metallo - acciaio al cromo molibdeno - brunite  
**1/2" - Square drive deep wall impact socket 6 points set - 10 pcs.**

1/2"



Cod.	Pz./Pcs.		
1800L/10	10	1	2490

Composizione:  
13-14-15-16-17-18-19-21-22-24



**Raccordo attacco quadro impact femmina 1/2"**  
acciaio al cromo molibdeno - brunito  
**1/2" - Adapter**

1/2"



Cod.				
<b>21079</b>	1/2"(F) x 3/4"(M)	60	1	195

**Snodo IMPACT universale 1/2"**  
acciaio al cromo molibdeno - brunito  
**1/2" universal joint impact**

1/2"



Cod.			
<b>1865</b>	60	1	137

**Assortimento 6 adattatori, riduttori e aumentatori IMPACT**  
in cassetta di plastica - bruniti  
**Impact adaptor and universal joint set**



1/4"

3/8"

1/2"

3/4"

Cod.	Pz./Pcs.		
<b>21073</b>	6	1	721

Composizione:

- 1/4 M-3/8 F • 1/2 M-3/4 F • 3/8 M-1/2 F
- 1/2 M-3/8 F • 3/8 M-1/4 F • 3/4 M-1/2 F

**Chiavi a bussola a mano esagonali 3/4"**  
acciaio al cromo vanadio - cromate  
**3/4" - Square drive sockets 6 points**

3/4"



Cod.				
<b>21203</b>	22	50	1	195
<b>21204</b>	24	50	1	205
<b>21206</b>	27	50	1	215
<b>21208</b>	30	52	1	285
<b>21209</b>	32	52	1	300
<b>21212</b>	36	57	1	420
<b>21213</b>	38	57	1	480
<b>21215</b>	41	62	1	550
<b>21216</b>	46	65	1	700
<b>21217</b>	50	68	1	800
<b>21218</b>	55	70	1	890

**Chiavi a bussola a mano poligonali in pollici 3/4"**  
acciaio al cromo vanadio - cromate  
**3/4" - Square drive sockets 12 points**

3/4"



POLLICI

Cod.				
<b>21227</b>	1 1/8"	55	1	216
<b>21229</b>	1 5/16"	60	1	340
<b>21232</b>	1 1/2"	60	1	476

**Asta con quadro scorrevole 3/4"**  
acciaio al cromo vanadio - cromata  
**3/4" - Sliding T bar**

3/4"



Cod.			
<b>21261</b>	450	1	1380

**Prolunghe attacco quadro maschio e femmina 3/4"**  
acciaio al cromo vanadio - cromate  
**3/4" - Extension bars**

3/4"



Cod.			
<b>21262</b>	100	1	415
<b>21263</b>	200	1	720
<b>21264</b>	400	1	1200

**Snodo cardanico attacco 3/4"**  
acciaio al cromo vanadio - cromata  
**3/4" - Universal joint**

3/4"



Cod.			
<b>21265</b>	105	1	631

**Raccordo attacco quadro 3/4"**  
acciaio al cromo vanadio - cromati  
**3/4" - Adapter**

3/4"



Cod.				
<b>21270</b>	3/4"(F) x 1/2"(M)	50	1	190

**Cricchetto reversibile attacco maschio 3/4"**  
24 denti - acciaio al cromo vanadio - cromato  
*3/4" - Reversible ratchet handle*

3/4"



Cod.			
21250	500	1	2600

**Cricchetto attacco femmina 3/4"**  
48 denti - acciaio al cromo vanadio - cromato  
*3/4" - Reversible ratchet handle - female square*

3/4"



Cod.			
21255	450	1	1861

**Assortimento 14 bussole esagonali e accessori 3/4"**  
in cassetta di metallo - acciaio al cromo vanadio - cromate  
*3/4" - Square drive socket 6 points and accessory set - 14 pcs.*

3/4"



Cod.	Pz./Pcs.		
21201	14	1	11100

Composizione:  
10 bussole mm 22-24-27-30-32-36-38-41-46-50  
1 cricchetto revers. mm 500  
1 asta quadro scorr. mm 450  
1 prolunga mm 100  
1 prolunga mm 200

**Chiavi a bussola esagonali IMPACT 3/4"**  
acciaio al cromo molibdeno - brunite  
*3/4" - Hexagonal square drive impact sockets*

3/4"



Cod.				
1924	24	50	1	370
1927	27	53	1	395
1930	30	53	1	420
1932	32	56	1	470
1933	33	56	1	490
1936	36	56	1	530
1941	41	62	1	570
1946	46	62	1	610
1950	50	62	1	650

**Chiavi a bussola esagonali lunghe IMPACT 3/4"**  
acciaio al cromo molibdeno - brunite  
*3/4" - Hexagonal square drive deep wall impact sockets*

3/4"



Cod.				
1924L	24	90	1	620
1927L	27	90	1	630
1930L	30	90	1	680
1932L	32	90	1	680
1933L	33	90	1	730
1936L	36	90	1	770
1938L	38	90	1	830
1941L	41	90	1	935
1946L	46	90	1	1140
1950L	50	90	1	1165

**Raccordi attacco quadro IMPACT 3/4"**  
*3/4" - Adapters*

3/4"



Cod.				
21074	3/4"(F)x 1"(M)	65	1	262
21075	3/4"(F) x 1/2"(M)	60	1	194

**Assortimento 8 chiavi a bussola esagonali IMPACT 3/4"**  
acciaio al cromo molibdeno - brunite - in cassetta di metallo  
*3/4" - Square drive impact socket 6 points set - 8 pcs.*

3/4"



Cod.	Pz./Pcs.		
1900/8	8	1	5250

Composizione:  
22-24-27-28-30-32-36-38

**Assortimento 8 chiavi a bussola esagonali lunghe IMPACT 3/4"**  
acciaio al cromo molibdeno - brunite - in cassetta di metallo  
*3/4" - Square drive deep wall impact socket 6 points set - 8 pcs.*



Cod.	Pz./Pcs.		
1900L/8	8	1	6974

Composizione:  
22-24-27-28-30-32-36-38

**Chiavi a bussola a mano esagonali 1"**  
acciaio al cromo vanadio - cromate  
**1" - Square drive sockets 6 points**

1"



Cod.	36	41	46	50	55	60	65	70	75	80
21312	36	41	46	50	55	60	65	70	75	80
21315	41	46	50	55	60	65	70	75	80	108
21316	46	50	55	60	65	70	75	80	102	108
21317	50	55	60	65	70	75	80	102	108	1
21318	55	60	65	70	75	80	102	108	1	1
21319	60	65	70	75	80	102	108	1	1	1
21320	65	70	75	80	102	108	1	1	1	1
21321	70	75	80	102	108	1	1	1	1	1
21322	75	80	102	1	1	1	1	1	1	1
21323	80	102	1	1	1	1	1	1	1	1

**Prolunghe attacco quadro maschio e femmina 1"**  
acciaio al cromo vanadio - cromate  
**1" - Extension bars**

1"



Cod.	200	400
21363	200	400
21364	400	1

**Snodo cardanico attacco 1"**  
acciaio al cromo vanadio - cromato  
**1" - Universal joint**

1"



Cod.	155
21365	155

**Testa quadro scorrevole 1"**  
acciaio al cromo vanadio - cromata  
**1" - Sliding "T" head**

1"



Cod.	80
21341	80

**Asta per testa a cricchetto e testa scorrevole 1"**  
acciaio al cromo vanadio - cromata  
**1" - Universal handle**

1"



Cod.	550
21342	550

**Testa a cricchetto reversibile attacco maschio 1"**  
36 denti a sgancio rapido  
acciaio al cromo vanadio - brunita  
**1" - Reversible ratchet head**

1"



Cod.	200
21340	200

**Raccordo attacco quadro IMPACT 1"**  
acciaio al cromo molibdeno - bruniti  
**1" - Adapters**

1"



Cod.	3/4"(M) x 1"(F)
21078	3/4"(M) x 1"(F)

**Assortimento 15 chiavi a bussola esagonali e accessori 1"**  
acciaio al cromo vanadio - cromate - in cassetta metallo  
**1" - Square drive socket 6 points and accessory set - 15 pcs.**

1"



Cod.	Pz./Pcs.
21300	15

Composizione:  
n° 10 bussole mm 36-41-46-50-55-60-65-70-75-80  
n° 1 testa a cricc. revers. mm 200  
n° 1 testa scorrevole mm 80  
n° 1 asta universale mm 550  
n° 1 prolunga mm 200  
n° 1 prolunga mm 400



**Assortimento 9 chiavi pentalobate forate attacco 1/4"**  
per smontaggio debimetri montate su barretta metallica  
**9 pcs socket for debimetri set**



Cod.	Pz./Pcs.		
<b>AT1476</b>	9	1	162



Composizione:  
T10 - T15 - T20 - T25 - T27 - T30 - T40 - T45 - T50

**Assortimento 22 inserti TX forati attacco esagonale da 10 mm**  
con bussole attacco 10x3/8" e 10x1/2"  
acciaio al silicio - sabbati - in cassetta plastica  
**10 mm - Bits with hole for star head screws - 22 pcs.**



Cod.	Pz./Pcs.		
<b>1001</b>	22	1	1000



Composizione:  
n° 10 inserti TX forati L. 30 mm.  
T10-T15-T20-T25-T27-T30-T40-T45-T50-T55  
n° 10 inserti TX forati L. 75 mm.  
T10-T15-T20-T25-T27-T30-T40-T45-T50-T55  
n° 2 bussole porta inserti: 1/2"x10 - 3/8"x10

**Assortimento 40 inserti TX-Esagonali-XZN**  
**attacco esagonale da 10 mm**  
acciaio al silicio - sabbati - in cassetta plastica  
**10 mm - Bits for star head screws,**  
**hexagonal head screws, XZN - 40 pcs.**



Cod.	Pz./Pcs.		
<b>1101</b>	40	1	1850



Composizione:  
n° 7 inserti esagonali L mm 30: 4-5-6-7-8-10-12  
n° 7 inserti esagonali L mm 75: 4-5-6-7-8-10-12  
n° 7 inserti TX L mm 30: T20-T25-T30-T40-T45-T50-T55  
n° 7 inserti TX L mm 75: T20-T25-T30-T40-T45-T50-T55  
n° 5 inserti XZN L mm 30: M5-M6-M8-M10-M12  
n° 5 inserti XZN L mm 75: M5-M6-M8-M10-M12  
n° 2 bussole porta inserti: 1/2"x10 - 3/8"x10

**Assortimento 44 inserti TX forati - Esagonali-XZN**  
**attacco esagonale da 10 mm**  
acciaio al silicio - sabbati - in cassetta plastica  
**10 mm - Bits for star head screws, with hole**  
**hexagonal head screws, XZN - 44 pcs.**



Cod.	Pz./Pcs.		
<b>1102</b>	44	1	2200



Composizione:  
n° 7 inserti esagonali L mm 30: 4-5-6-7-8-10-12  
n° 7 inserti esagonali L mm 75: 4-5-6-7-8-10-12  
n° 7 inserti TX forati L mm 30: T20-T25-T30-T40-T45-T50-T55  
n° 7 inserti TX forati L mm 75: T20-T25-T30-T40-T45-T50-T55  
n° 5 inserti XZN L mm 30: M5-M6-M8-M10-M12  
n° 5 inserti XZN L mm 75: M5-M6-M8-M10-M12  
n° 2 bussole porta inserti: 1/2"x10 - 3/8"x10  
n° 1 bussole TX55 L. 140  
n° 1 bussole TX70 L. 100

**Serie 15 inserti TX in cassetta plastica**  
**attacco esagonale 10mm**  
**Power star bits 15 pcs.**



Cod.	Pz./Pcs.		
<b>1300</b>	15	1	600



Composizione:  
n° 7 inserti TX L mm 30: T20-T25-T30-T40-T45-T50-T55  
n° 7 inserti TX L mm 75: T20-T25-T30-T40-T45-T50-T55  
n° 1 bussola porta inserti: 1/2"x10 mm

**Serie 15 inserti esagonali in cassetta plastica**  
**attacco esagonale 10mm**  
**Power hex bits 15 pcs.**



Cod.	Pz./Pcs.		
<b>1400</b>	15	1	650



Composizione:  
n° 7 inserti esagonali L mm 30: 4-5-6-7-8-10-12  
n° 7 inserti esagonali L mm 75: 4-5-6-7-8-10-12  
n° 1 bussola porta inserti: 1/2"x10 mm



**Serie 11 inserti XZN attacco esagonale 10mm**  
**Power XZN bits 11 pcs.**



Cod.	Pz./Pcs.		
1500	11	1	510

Composizione:  
 n° 5 inserti XZN L mm 30: M5-M6-M8-M10-M12  
 n° 5 inserti XZN L mm 75: M5-M6-M8-M10-M12  
 n° 1 bussola porta inserti: 1/2"x10 mm.

**Assortimento 22 inserti RIBE attacco esagonale da 10 mm con bussole attacco 10x3/8" e 10x1/2"**  
 acciaio al silicio - sabbiati  
**Socket, RIBE bit set - 20 pcs.**



Cod.	Pz./Pcs.		
AT1115	22	1	1300

Composizione:

	Pz./Pcs.
RIBE M. 5-6-7-8-9-10-11-12-13 L 30 mm	9
RIBE M. 5-6-7-8-9-10-10,3-11-12-13-14 L 75 mm	11
bussole portainseriti 3/8" - 1/2"	2

**Assortimento 30 chiavi bussola con esagono maschio attacco 1/2"**  
 acciaio cromo vanadio  
**Socket, hex bit set - 30 pcs.**

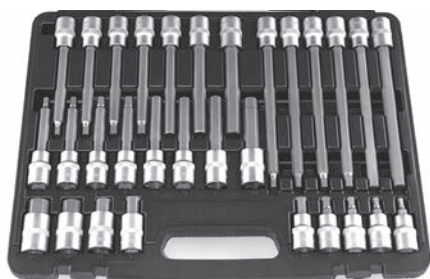

Cod.	Pz./Pcs.		
21168/C30	30	1	5170

Composizione:  
 n° 9 - Bussole L 55 mm 5-6-7-8-10-12-14-17-19  
 n° 8 - Bussole L 100 mm 5-6-7-8-10-11-12-13  
 n° 7 - Bussole L 140 mm 5-6-7-8-10-12-14  
 n° 6 - Bussole L 200 mm 5-6-7-8-10-12

**Assortimento 26 chiavi bussola con inserto XZN maschio attacco 1/2"**  
 acciaio cromo vanadio  
**Socket, XZN bit set - 26 pcs.**

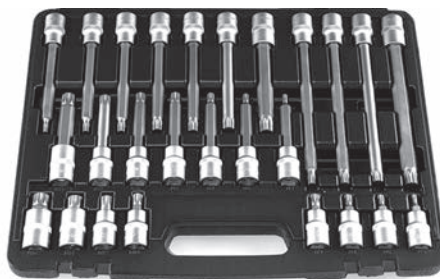

Cod.	Pz./Pcs.		
21180/C26	26	1	4570

Composizione:  
 n° 9 - Bussole L 55 mm 5-6-7-8-9-10-12-14-16  
 n° 7 - Bussole L 100 mm 5-6-8-9-10-12-14  
 n° 7 - Bussole L 140 mm 5-6-8-9-10-12-14  
 n° 4 - Bussole L 200 mm 8-10-12-14

**Assortimento 32 chiavi bussola con inserto TX maschio attacco 1/2"**  
 acciaio cromo vanadio  
**Socket, star bit set - 32 pcs.**

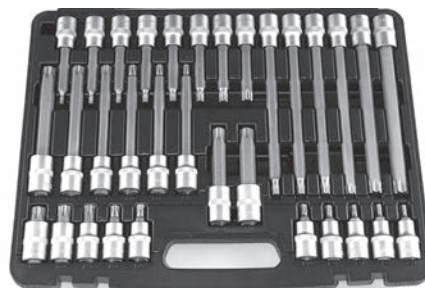

Cod.	Pz./Pcs.		
21170/C32	32	1	5140

Composizione:  
 n° 10 - Bussole L 55 mm T20-25-27-30-40-45-50-55-60-70  
 n° 10 - Bussole L 100 mm T20-25-27-30-40-45-50-55-60-70  
 n° 6 - Bussole L 140 mm T40-45-50-55-60-70  
 n° 6 - Bussole L 200 mm T40-45-50-55-60-70

**Assortimento 8 chiavi a bussola TX-Esagonali-XZN-RIBE - attacco 1/2"**  
 in cassetta di metallo  
**1/2" - Socket set for removal cilinder head bolts - 8 pcs.**

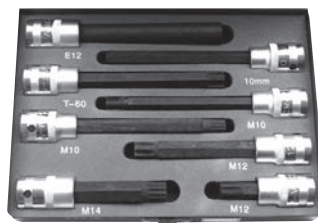

Cod.	Pz./Pcs.		
21180/C8	8	1	1956

Composizione:  
 n° 1 bussola TX femmina E12x140  
 n° 1 bussola ES mm 10x140  
 n° 1 bussola TX 60x140  
 n° 2 bussole XZN M10x140 - M14x140  
 n° 3 bussole RIBE M10x140 - M12x120 - M12x65



**Assortimento 32 chiavi bussola con inserto RIBE maschio - attacco 1/2"**  
acciaio cromo vanadio  
*Socket, RIBE bit set - 32 pcs.*

1/2"

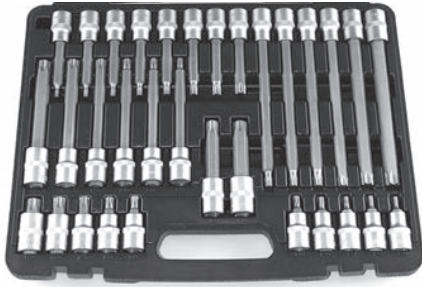

Cod.	Pz./Pcs.		
21190/C32	32	1	4620



Composizione:

n° 9 - Bussole L 55 mm 5-6-7-8-9-10-12-13-14  
n° 9 - Bussole L 100 mm 5-6-7-8-9-10-12-13-14  
n° 7 - Bussole L 140 mm 8-9-10-10,3-12-13-14  
n° 7 - Bussole L 200 mm 8-9-10-10,3-12-13-14

**Assortimento 9 chiavi a bussole TX IMPACT attacco 1/2"**  
*Socket star impact bit set - 9 pcs.*

1/2"



Cod.	Pz./Pcs.			
2117/9	9	78	1	1025



Composizione:

T20 - T25 - T27 - T30 - T40 - T45 - T50 - T55 - T60

**Assortimento 8 chiavi a bussole esagonali IMPACT attacco da 1/2"**  
*Hex impact socket bit set - 8 pcs.*

1/2"



Cod.	Pz./Pcs.			
2116/9	8	78	1	1310



Composizione:

4 - 5 - 6 - 8 - 10 - 14 - 17 - 19

**Assortimento 6 chiavi dadi mozzi XZN IMPACT particolarmente adatto per VW, AUDI**  
*1/2" impact sockets, XZN bit set*

1/2"



Cod.	Pz./Pcs.		
AT1391	6	1	800



Composizione:

1/2" mm 14, 16, 18 L 40 - 1/2" mm 14, 16, 18 L 75

**Assortimento 7 chiavi a bussola con inserto esagonale attacco 1/2"**  
- montate su barretta metallica  
acciaio al cromo vanadio - cromate  
*Socket, hex bit set - 7 pcs.*

1/2"



Cod.	Pz./Pcs.		
21168/7	7	1	658

Composizione:

5x55 - 6x55 - 7x55 - 8x55 - 10x55 - 12x55 - 14x55

**Assortimento 10 chiavi a bussola con inserto esagonale attacco 1/2" - 3/8" - 1/4"**  
- montate su barretta metallica  
acciaio al cromo vanadio - cromate  
*Socket wrench hex bit set - 10 pcs.*

1/2"

3/8"

1/4"



Cod.	Pz./Pcs.		
21168/10	10	1	720

Composizione:

1/4" mm 4 - 5 - 6 - 7 - 8 - 3/8" mm 10 - 12 - 14 - 1/2" mm 17 - 19

**Assortimento 6 chiavi a bussola con inserto XZN attacco 1/2"**  
montate su barretta metallica  
acciaio al cromo vanadio - cromate  
*Socket, XZN bit set - 6 pcs.*

1/2"



Cod.	Pz./Pcs.		
21188/6	6	1	172

Composizione:

M5x100 - M6x100 - M8x100 - M10x100 - M12x100 - M14x100

**Assortimento 12 chiavi a bussola con inserto TX attacco 1/2" - 3/8" - 1/4"**  
- montate su barretta metallica  
acciaio al cromo vanadio - cromate  
*Socket star bit set - 12 pcs.*

1/2"

3/8"

1/4"



Cod.	Pz./Pcs.		
21188/12	12	1	420

Composizione:

1/4" T8-T10-T15-T20-T25-T27 - 3/8" T30-T40-T45-T50-T55 - 1/2" T60

**Assortimento 6 chiavi a bussola femmina TX attacco 1/2"**  
per serraggio testate motori (Renault, Opel)  
*Specific star socket holder set - 6 pcs.*



Cod.	Pz./Pcs.			
1999	6	140	1	2030

Composizione:  
E10 - E12 - E14 - E16 - E18 - E20

**Assortimento 12 chiavi a bussola femmina TX attacco da 1/4"-3/8"** - montate su barretta metallica  
*Star socket set - 12 pcs.*



Cod.	Pz./Pcs.		
2001	12	1	340

Composizione:  
1/4" E4 - E5 - E6 - E7 - E8 - 3/8" E10 - E11 - E12 - E14 - E16 - E18 - E20

**Chiavi a bussola a mano TX femmina attacco 1/4"**  
acciaio al cromo vanadio - cromate  
*1/4" Star sockets*



Cod.				
1990	E4	1/4"x25	1	13
1991	E5	1/4"x25	1	13
1992	E6	1/4"x25	1	14
1993	E7	1/4"x25	1	14
1994	E8	1/4"x25	1	14

**Chiavi a bussola a mano TX femmina attacco 3/8"**  
acciaio al cromo vanadio - cromate  
*3/8" Star sockets*

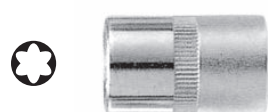

Cod.				
2004	E10	3/8"x28	1	27
2005	E11	3/8"x28	1	27
2006	E12	3/8"x28	1	28
2007	E14	3/8"x28	1	32

**Chiavi a bussola a mano TX femmina attacco 1/2"**  
acciaio al cromo vanadio - cromate  
*1/2" Star sockets*



Cod.				
2008	E8	1/2"x38	1	50
2010	E10	1/2"x38	1	50
2012	E12	1/2"x38	1	51
2014	E14	1/2"x38	1	53
2016	E16	1/2"x38	1	58
2018	E18	1/2"x38	1	59
2020	E20	1/2"x38	1	70

**Chiavi a bussola a mano TX femmina lunghe attacco 1/2"**  
acciaio al cromo vanadio - cromate  
*1/2" deep Star sockets*



Cod.				
2022	E10	1/2"x50	1	110
2023	E11	1/2"x50	1	110
2024	E12	1/2"x50	1	114
2025	E14	1/2"x50	1	114
2026	E16	1/2"x50	1	120
2027	E18	1/2"x50	1	125
2028	E20	1/2"x50	1	175
2029	E22	1/2"x50	1	196
2030	E24	1/2"x50	1	235

**Chiavi a bussola con inserto esagonale attacco 1/2"**  
acciaio al cromo vanadio - cromate  
*1/2" - Hexagonal screwdriver sockets mm. 55 long*



Cod.				
21160	4	55	1	70
21161	5	55	1	70
21162	6	55	1	70
21163	8	55	1	70
21164	10	55	1	75
21165	12	55	1	80
21167	17	55	1	144

**Chiavi a bussola con inserto esagonale lungo attacco 1/2"**  
acciaio al cromo vanadio - cromate  
*1/2" - Hexagonal screwdriver sockets mm. 100 long*



Cod.				
21162L	6	100	1	80
21163L	8	100	1	90
21164L	10	100	1	128

SOCKETS AND ACCESSORIES - CHIAVI A BUSSOLA E INSERTI





**Chiavi a bussola con inserto TX attacco 1/2"**  
acciaio al cromo vanadio - cromate  
**1/2" - Star screwdriver sockets mm. 55 long**

1/2"



Cod.	★	▬	▭	⚖
21171	T20	55	1	70
21172	T25	55	1	70
21173	T27	55	1	70
21174	T30	55	1	70
21175	T40	55	1	70
21176	T45	55	1	70
21177	T50	55	1	70
21178	T55	55	1	75
21179	T60	55	1	80

**Chiavi a bussola con inserto TX lungo attacco 1/2"**  
acciaio al cromo vanadio - cromate  
**1/2" - Star screwdriver sockets**

1/2"



Cod.	★	▬	▭	⚖
21175L	T40	100	1	80
21176L	T45	100	1	100
21176LE	T45	120	1	135
21177LE	T50	140	1	150
21178LE	T55	140	1	152
21179LE	T60	140	1	188
21180LE	T70	140	1	231

**Chiavi a bussola con inserto forato TX attacco 1/2"**  
acciaio al cromo vanadio - cromate  
**1/2" - Star screwdriver sockets - tamperproof**

1/2"



Cod.	★	▬	▭	⚖
21171F	T20	55	1	72
21172F	T25	55	1	73
21173F	T27	55	1	73
21174F	T30	55	1	73
21175F	T40	55	1	73
21176F	T45	55	1	74
21177F	T50	55	1	74
21178F	T55	55	1	82
21179F	T60	55	1	109
21180F	T70	55	1	112

**Chiave a bussola con inserto TX forato attacco 1/2"**  
particolarmente adatta per tappo olio vetture Audi, Ford  
acciaio al cromo vanadio - cromata  
**1/2" wrench oil plugs with star bit - tamperproof**

1/2"



Cod.	★	▬	▭	⚖
AT1293	T70	120	1	178

**Chiavi a bussola con inserto XZN attacco 1/2"**  
acciaio al cromo vanadio - cromate  
**1/2" - XZN screwdriver sockets mm. 55 long**

1/2"



Cod.	★	▬	▭	⚖
21181	M5	55	1	74
21182	M6	55	1	74
21183	M8	55	1	75
21184	M10	55	1	82
21185	M12	55	1	112
21186	M14	55	1	114
21187	M16	55	1	119

**Chiavi a bussola con inserto XZN lungo attacco 1/2"**  
acciaio al cromo vanadio - cromate  
**1/2" - XZN screwdriver sockets mm. 100 long**

1/2"



Cod.	★	▬	▭	⚖
21181L	M5	100	1	93
21182L	M6	100	1	93
21183L	M8	100	1	94
21184L	M10	100	1	112
21185L	M12	100	1	170
21186L	M14	100	1	175

**Chiave a bussola con inserto XZN forato attacco da 1/2"**  
particolarmente adatta per tappo olio vetture Audi  
acciaio al cromo vanadio - cromata  
**Wrench oil plugs with XZN bit - tamperproof**

1/2"



Cod.	★	▬	▭	⚖
AT1292	M16	55	1	139

**Chiavi a bussola esagonali**  
acciaio al cromo vanadio - satinare  
manico bi-componente  
**Socket wrenches**

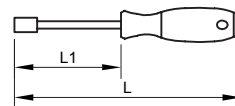

Cod.	○	LxL1	▭	⚖
22031	4	210x90	8	83
22032	5	210x90	8	84
22034	6	210x90	8	94
22035	7	240x125	8	95
22036	8	240x125	8	96
22037	9	210x90	8	97
22038	10	210x90	8	122
22039	11	210x90	5	147
22040	12	210x90	5	148
22041	13	245x125	5	150



LINEA BASIC

La misura fuori manico  
può essere soggetta  
a variazioni di lunghezza



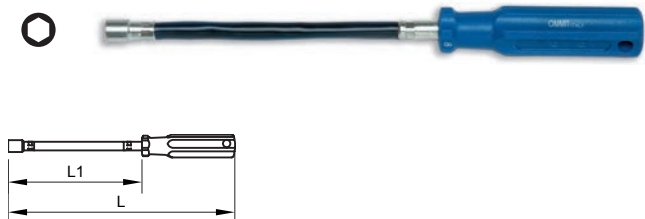



**Chiavi a bussola esagonali su albero flessibile**  
impugnatura materiale plastico  
**Flexible hexagonal head wrenches**

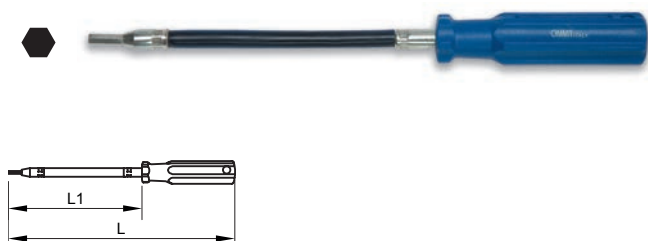

Cod.		LxL1		
<b>22201</b>	5	250x150	12	110
<b>22202</b>	5,5	250x150	12	110
<b>22203</b>	6	250x150	12	110
<b>22204</b>	7	250x150	12	115
<b>22205</b>	8	250x150	12	115
<b>22206</b>	9	250x150	12	115
<b>22207</b>	10	250x150	12	115

**Chiavi maschio esagonale ad albero flessibile**  
impugnatura materiale plastico  
**Hexagonal flexible wrenches**





Cod.		LxL1		
<b>33001</b>	2	260x155	12	110
<b>33002</b>	2,5	260x155	12	110
<b>33003</b>	3	260x155	12	110
<b>33005</b>	4	260x155	12	110
<b>33007</b>	5	270x170	12	115

**Chiave a T multifunzione per bussole ed inserti 1/4"**  
con asta scorrevole e dispositivo per avvitiamenti rapidi  
acciaio al cromo vanadio fosfatata.  
**Multi functional T wrench for 1/4" sockets and bits with sliding bar and device for fast screwings**

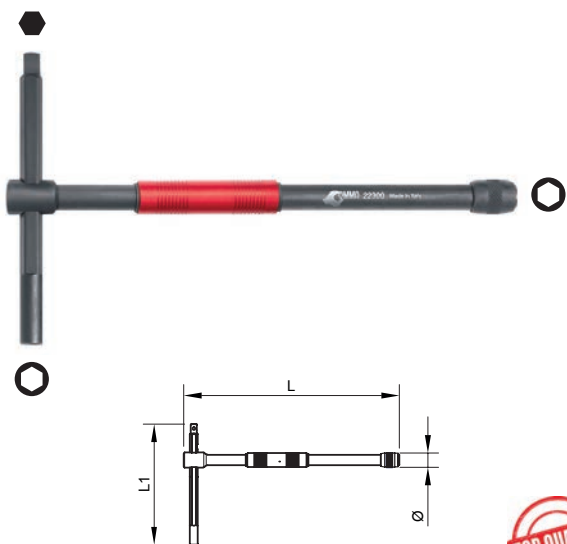
**1/4"**







Cod.		LxL1	Ø		
<b>22300</b>	1/4"	210x120	14	4	230

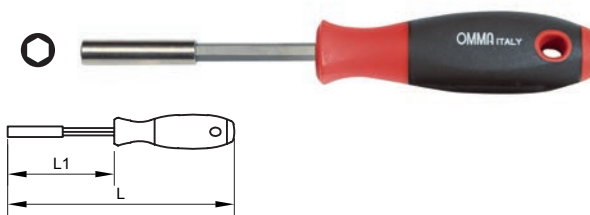

**Chiave a bussola magnetica per inserti 1/4"**  
manico bi-componente  
**Magnetic bit holder for 1/4" bits**

**1/4"**





Cod.		LxL1		
<b>22281</b>	1/4"	210x100	4	230

**Chiavi a bussola magnetiche per inserti 1/4"**  
manico bi-componente - con sgancio rapido  
**Magnetic bit holders with quick release for 1/4" bits**

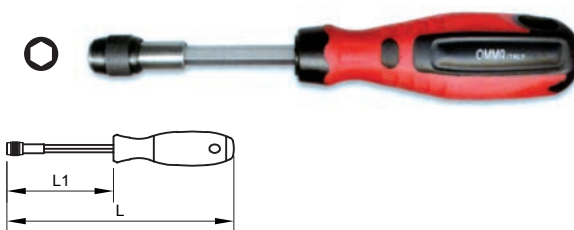
**1/4"**





Cod.		LxL1		
<b>22282</b>	1/4"	190x80	6	100
<b>22283</b>	1/4"	230x115	6	120

**Chiave a bussola flessibile magnetica per inserti 1/4"**  
impugnatura materiale plastico  
**Flexible magnetic bit holder for 1/4" hexagonal bits**

**1/4"**





Cod.		LxL1		
<b>22251</b>	1/4"	270x170	12	120

**Serie 3 chiavi flessibili lunghe con 20 accessori**  
Per regolazione carburazione e per fascette stringitubo in profondità,  
sono inoltre adatte per scatolati e parafanghi in carrozzeria.  
**Flexible hose clip nut driver 500 mm**

**1/4"**



Cod.	Pz./Pcs.			
<b>33011</b>	23	600	1	1020

Composizione:	Pz./Pcs.
Chiave flessibile porta bits 1/4"	1
Chiave flessibile quadro maschio 1/4"	1
Chiave flessibile esagono 7 mm	1
Bussole attacco 1/4" esag. mm 5-6-7-8-9-10-11-12-13	9
Inserti attacco 1/4" - 2 PH - 2 taglio - 6 torx	10
Inserto attacco 1/4" da 1/4"	1

**Chiave doppia a cricchetto reversibile snodata**  
**1/4" maschio e 1/4" per inserti - extra lunga**  
 acciaio al cromo vanadio - cromata  
*Extra long double flexible and reversible head*  
*1/4" socket and 1/4" bits ratchet handle*

1/4"



Cod.	○	■	L1		
<b>AT2238</b>	6,35 - 1/4"	300	1	185	

**Inserti per viti con intaglio attacco 1/4"**  
 acciaio al silicio - sabbati  
*1/4" hexagonal bits for slot head screws*

1/4"



Cod.	●				
<b>87001</b>	4	25	10	4	
<b>87002</b>	5	25	10	4	
<b>87003</b>	6	25	10	5	
<b>87004</b>	7	25	10	5	
<b>87011</b>	4	40	10	8	
<b>87012</b>	5	40	10	8	
<b>87013</b>	6	40	10	8	
<b>87014</b>	7	40	10	9	
<b>87015</b>	8	40	10	11	
<b>87016</b>	9	40	10	13	
<b>87017</b>	10	40	10	15	

**Inserti per viti a croce Phillips attacco 1/4"**  
 acciaio al silicio - sabbati  
*1/4" hexagonal bits for Phillips head screws*

1/4"



Cod.	+				
<b>87101</b>	PH 0	25	10	4	
<b>87102</b>	PH 1	25	10	4	
<b>87103</b>	PH 2	25	10	5	
<b>87104</b>	PH 3	25	10	5	

**Inserti per viti a croce pozidrive attacco 1/4"**  
 acciaio al silicio - sabbati  
*1/4" hexagonal bits for Pozidrive head screws*

1/4"

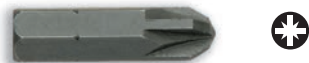

Cod.	+				
<b>87201</b>	PZ 1	25	10	5	
<b>87202</b>	PZ 2	25	10	5	
<b>87203</b>	PZ 3	25	10	6	

**Inserti per viti esagonali attacco 1/4"**  
 acciaio al silicio - sabbati  
*1/4" hexagonal bits for hexagonal head screws*

1/4"



Cod.				
<b>87302</b>	2,5	25	10	4
<b>87303</b>	3	25	10	4
<b>87304</b>	3,5	25	10	5
<b>87305</b>	4	25	10	5
<b>87306</b>	5	25	10	6
<b>87307</b>	6	25	10	8

**Inserti per viti TX attacco 1/4"**  
 acciaio al silicio - sabbati  
*1/4" hexagonal bits for Star head screws*

1/4"



Cod.	*			
<b>87353</b>	T09	25	10	4
<b>87354</b>	T10	25	10	4
<b>87355</b>	T15	25	10	4
<b>87356</b>	T20	25	10	4
<b>87357</b>	T25	25	10	5
<b>87358</b>	T27	25	10	5
<b>87359</b>	T30	25	10	5
<b>87360</b>	T40	25	10	6

**Inserti per viti TX forati attacco 1/4"**  
 acciaio al silicio - sabbati  
*1/4" hexagonal bits for Star head screws with hole*

1/4"



Cod.	*			
<b>87371</b>	T10	25	10	4
<b>87372</b>	T15	25	10	4
<b>87373</b>	T20	25	10	4
<b>87374</b>	T25	25	10	5
<b>87375</b>	T27	25	10	5
<b>87376</b>	T30	25	10	5
<b>87377</b>	T40	25	10	6

**Chiavi a bussola esagonali magnetiche attacco 1/4"**  
 acciaio al silicio - sabbati  
*1/4" Magnetic sockets 6 points*

1/4"



Cod.	○			
<b>87380</b>	5,5	42	1	14
<b>87381</b>	7	42	1	17
<b>87382</b>	8	42	1	19
<b>87383</b>	10	45	1	23
<b>87384</b>	13	45	1	25

### Inserti per viti con intaglio attacco 1/4"

acciaio al silicio - sabbiati

**1/4" hexagonal long type bits for slot head screws**

1/4"



Cod.				
87401	4	50	10	9
87402	5	50	10	10
87403	6	50	10	11

### Inserti per viti a croce Phillips attacco 1/4"

acciaio al silicio - sabbiati

**1/4" hexagonal long type bits for Phillips screws**

1/4"



Cod.				
87411	PH 1	50	10	10
87412	PH 2	50	10	11
87413	PH 3	50	10	12
87421	PH 1	75	10	16
87422	PH 2	75	10	16
87431	PH 1	100	10	18
87432	PH 2	100	10	22

### Inserti per viti a croce Pozidrive attacco 1/4"

acciaio al silicio - sabbiati

**1/4" hexagonal long type bits for Pozidrive head screws**

1/4"



Cod.				
87441	PZ 1	50	10	10
87442	PZ 2	50	10	11
87443	PZ 3	50	10	12

### Mandrini magnetici portainseri attacco 1/4"

acciaio al cromo vanadio - sabbiati

**1/4" magnetic bit holders**

1/4"



Cod.			
87531	75	1	37

### Portainseri magnetici per inserti da 1/4"

attacco 1/4" con sgancio rapido

**1/4" magnetic bit holders with quick release**

1/4"



Cod.			
87535	50	1	20
87536	75	1	25

### Adattatori quadro maschio attacco 1/4"

acciaio al cromo vanadio - sabbiati

**1/4" adapters**

1/4"



Cod.				
87561	1/4"	50	1	15
87562	3/8"	50	1	25

### Inserti per viti esagonali con attacco 10 mm

acciaio al silicio - sabbiati

**10 mm - Bits for hexagonal head screws**



Cod.				
1404	4	30	1	14
1405	5	30	1	14
1406	6	30	1	14
1407	7	30	1	16
1408	8	30	1	18
1410	10	30	1	20
1412	12	30	1	24

### Inserti per viti esagonali con attacco 10 mm

acciaio al silicio - sabbiati

**10 mm - Bits for hexagonal head screws**



Cod.				
1404L	4	75	1	44
1405L	5	75	1	44
1406L	6	75	1	44
1407L	7	75	1	44
1408L	8	75	1	46
1410L	10	75	1	50
1412L	12	75	1	68

### Inserti per viti TX con attacco 10 mm

acciaio al silicio - sabbiati

**10 mm - Bits for star head screws**



Cod.				
1320	T20	30	1	14
1325	T25	30	1	14
1327	T27	30	1	14
1330	T30	30	1	14
1340	T40	30	1	16
1345	T45	30	1	16
1350	T50	30	1	18
1355	T55	30	1	22
1360	T60	30	1	42

**Inserti per viti TX con attacco 10 mm**  
acciaio al silicio - sabbiati  
*10 mm - Bits for star head screws*



Cod.				
1320L	T20	75	1	42
1325L	T25	75	1	42
1327L	T27	75	1	42
1330L	T30	75	1	44
1340L	T40	75	1	44
1345L	T45	75	1	46
1350L	T50	75	1	48
1355L	T55	75	1	66
1360L	T60	75	1	66

**Inserti per viti TX forati con attacco 10 mm**  
acciaio al silicio - sabbiati  
*10 mm - Bits with hole for star head screws*



Cod.				
1210	T10	30	1	14
1215	T15	30	1	14
1220	T20	30	1	14
1225	T25	30	1	14
1227	T27	30	1	14
1230	T30	30	1	14
1240	T40	30	1	14
1245	T45	30	1	16
1250	T50	30	1	16
1255	T55	30	1	18

**Inserti per viti TX forati con attacco 10 mm**  
acciaio al silicio - sabbiati  
*10 mm - Bits with hole for star head screws*



Cod.				
1210L	T10	75	1	42
1215L	T15	75	1	42
1220L	T20	75	1	42
1225L	T25	75	1	42
1227L	T27	75	1	42
1230L	T30	75	1	42
1240L	T40	75	1	44
1245L	T45	75	1	44
1250L	T50	75	1	46
1255L	T55	75	1	48

**Inserti per viti XZN con attacco 10 mm**  
acciaio al silicio - sabbiati  
*10 mm - Bits for XZN screws*



Cod.				
1505	M5	30	1	14
1506	M6	30	1	16
1508	M8	30	1	18
1510	M10	30	1	20
1512	M12	30	1	24

**Inserti per viti XZN con attacco 10 mm**  
acciaio al silicio - sabbiati  
*10 mm - Bits for XZN head screws*



Cod.				
1505L	M5	75	1	44
1506L	M6	75	1	44
1508L	M8	75	1	44
1510L	M10	75	1	44
1512L	M12	75	1	46

**Inserti per viti RIBE con attacco 10 mm**  
acciaio al silicio - sabbiati  
*10 mm - bits for RIBE head screws*



Cod.				
AT1116	5	30	1	14
AT1117	6	30	1	14
AT1118	7	30	1	14
AT1119	8	30	1	15
AT1120	9	30	1	16
AT1121	10	30	1	17
AT1122	11	30	1	19
AT1123	12	30	1	21
AT1124	13	30	1	22

**Inserti per viti RIBE con attacco 10 mm**  
acciaio al silicio - sabbiati  
*10 mm - bits for RIBE head screws*



Cod.				
AT1125	5	100	1	44
AT1126	6	100	1	60
AT1127	7	100	1	60
AT1128	8	100	1	61
AT1129	9	100	1	63
AT1130	10	100	1	64
AT1131	10,5	100	1	74
AT1132	11	100	1	78
AT1133	12	100	1	82
AT1134	13	100	1	95
AT1135	14	100	1	108

**Bussole portainseriti**  
acciaio al cromo vanadio - cromate  
*Bit holders*



3/8"

1/2"

Cod.				
1601	3/8"x10	28	1	40
1605	1/2"x10	38	1	65
1610	1/2"x14	38	1	75